



Installation and Setup Guide

CS8500 Commercial
Programmable Thermostat Series

507611-04
05/2024

Supersedes 02/2023

Table of Contents

Shipping and Packing List.....	3	BACnet with M3/M4 Unit Controller.....	11
CS8500 Features.....	3	Network Topology.....	11
Product Dimensions.....	4	CS8500 Set Point Change.....	11
Unit Dimensions (H x W x D).....	4	CS8500 Occupancy Override.....	12
Wall Plate Dimensions (H x W).....	4	BACnet Canceling Override.....	12
Wiring Specifications.....	4	Sensor Inputs.....	12
Communication Wire.....	4	M3 Unit Controller Setup.....	12
Remote Sensor Wire.....	4	M4 Unit Controller Setup.....	13
Transformer Wire.....	4	CS8500 Setup.....	14
Installation.....	5	CS8500 Sensor Failure.....	14
Terminal Connections.....	6	Functions Not Supported with BACnet Operation.....	14
Purpose.....	6	CS8500 Troubleshooting.....	14
Wiring CS8500 (with or without CO ₂ Sensor).....	7	M3/M4 Unit Controller - Setting Return Air	
Installing Indoor Temperature Sensors.....	7	Temperature Limits.....	15
Installing Occupancy Sensor.....	8	Menu.....	16
Sequence of Operations.....	8	Technician Settings.....	16
Unit Controller S-Bus Setup.....	9	Parameter Settings Based on System Configuration...	16
M1 / M2 Unit Controller Setup.....	9	Parameter Descriptions.....	17
M1 / M2 Unit Controller - Control Mode and		System Status Descriptions.....	21
Backup Set Points Setup.....	9	Error Codes and Reminders.....	25
M3 Unit Controller Setup.....	10		
M4 Unit Controller Setup.....	10		
CS8500 Setup.....	11		

Shipping and Packing List

Verify the following items have been included with in the packing:

Table 1. Packing List

Quantity	Item
1	CS8500 (non-zoning) with back plate
1	Wall plate
2	Wall anchors
2	Screws (M3.5x24mm self-tapping)
1	Warranty
1	User guide
1	Setup and installation guide



WARNING

Improper installation, adjustment, alteration, service or maintenance can cause property damage, personal injury or loss of life.

Installation and service must be performed by a licensed professional HVAC installer (or equivalent) or service agency.

CS8500 Features

The CS8500 is a commercial, electronic, 7-day, multi-stage, programmable, touchscreen thermostat. This CS8500 provides temperature control for packaged gas/electric, electric/electric, and heat pump for up to 4-heat / 4-cool multi-stage roof top unit systems.

- Models are available with or without CO₂ sensing capabilities.
- For use with Model L™ and Enlight™ commercial rooftop units equipped with Lennox® CORE Unit Controller.
- For use with Energence® commercial rooftop units equipped with Prodigy®.
- CO₂ models can be used to control Lennox' premium rooftop unit Demand Control Ventilation features based on CO₂ set points and conditions stored in the unit controller.

The CS8500 also feature enhanced capabilities including remote temperature sensing, dehumidification and control, economizer control and custom reminders.

- Built-in humidification monitoring - range 5% to 95% with accuracy at + 5%.
- Built-in carbon dioxide monitoring version only - range 400-2000 ppm, range 5% to 95% and with accuracy at + 40 ppm + 3% or reading @ 77°F (25°C). Sensor has built-in self-calibration algorithm.

- Temperature monitoring - two internal thermistors, range 32°F (0°C) to 99°F (37°C). Measurement accuracy + 0.5°F (-17.5°C).
- External indoor temperature sensor connections 10kΩ (47W37) or 11kΩ (94L61) — up to nine (9) sensor in parallel may be used.
- External occupancy sensor connection (24VAC).
- Supports 50 and 60Hz operations.
- Maximum load per terminal - 1 amp
- Power supply range 18 to 30 VAC
- Temperature control is (+/- 1°F) of set point

Product Dimensions

Unit Dimensions (H x W x D)

Case dimensions: 3-5/16 x 4-5/16 x 7/8 in.
(84 x 110 x 22mm)

Wall Plate Dimensions (H x W)

Plate dimensions: 4-1/2" x 5-3/4" (114 x 146mm)

Wiring Specifications

Communication Wire

Use one of the following Lennox communication cables (twisted pair with shield plenum):

Table 2. Twisted Pair Communication Wiring (S-Bus - Yellow)

Catalog Numbers	Item
27M19	500 foot roll
94L63	1000 foot roll
68M25	2500 foot roll



CAUTION

This is a 24VAC low-voltage sensor. Do not install on voltages higher than 30VAC.

Do not short (jumper) across terminals to test installation. This will damage the sensor and void the warranty.

Remote Sensor Wire

All remote sensors use standard non-shielded thermostat wiring; sensors may be wired using two wires of a multiple wire cable.

NOTE: *Outdoor and indoor sensor wire runs should not exceed 300 feet (100m).*

Transformer Wire

Standard thermostat wire (one pair 20 AWG minimum) may be used to wire the CS8500 to the optional wall plug 24VAC transformer (18M13) or other field-provided 2VA minimum, 24VAC output transformer.

Installation

1. Unpacked the CS8500 and open the case with a thin-blade screwdriver (see "Figure 1. Removing Back Plate" on page 5).
2. Place between wall base and unit and twist to separate unit from base.

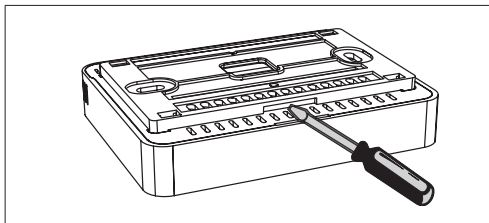

Figure 1. Removing Back Plate

3. Select a location for the sensor about five (5) feet (1.5 meters) above the floor in an area with good air circulation at average temperature.
4. Do not install the CS8500 where it can be affected by:
 - Drafts or dead spots behind doors and in corners.
 - Entrance or automatic doors.
 - Heat generating equipment such as kitchen equipment.
 - Enclose environment unless a remote indoor sensor is used.

- Hot or cold air from ducts.
 - Radiant heat from sun or appliances.
 - Concealed pipes and chimneys.
 - Non-heated or non-cooled areas such as an outside wall behind the sensor.
5. Use the following steps:
 - a. Determine location using best practices.
 - b. Use the provided wall plate as a template to determine location cutout for wiring and location for wall anchors.

NOTE: *The use of the provided wall plate is optional.*

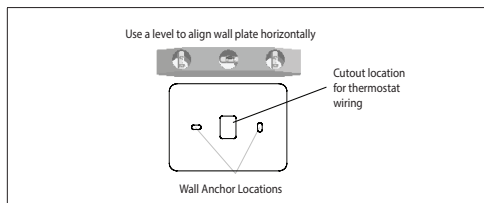

Figure 2. Level Wall Plate

- c. Cut or drill a small hole approximately 3/4" x 3/4" for wiring.
- d. Pull about three inches of all wiring through opening and remove outer communication wire jacket.
- e. Trim 1/4" insulation from end of each wire.
- f. Drill 3/16" holes at marked locations on wall for wall anchors.

- g. Route the CS8500 and outdoor temperature sensor (optional) wiring from wall through center openings on wall plate (use is optional) and back plate (see “Figure 3. Route Wiring” on page 6).

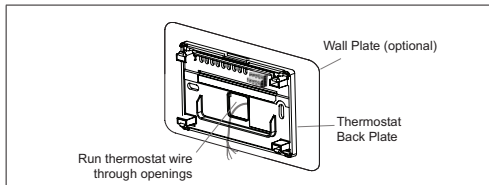

Figure 3. Route Wiring

- h. Secure back plate and wall plate (optional) to wall with the two provided mounting screws.

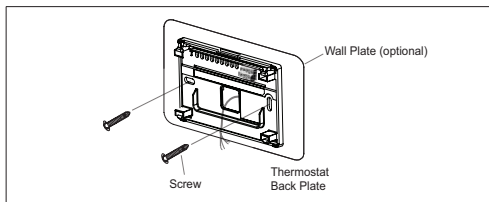

Figure 4. Secure Back Plate

NOTE: Remember to seal the hole in the wall with a suitable material to prevent drafts from entering the zone sensor case. Not doing so could affect the internal temperature and humidity sensors.

Terminal Connections

External sensors use standard thermostat wiring; and may be wired using two wires of a multiple wire cable. Wire run should not exceed 300 feet (100m).

Terminals CM- and CM+ will use wiring as referenced in “Table 2. Twisted Pair Communication Wiring (S-Bus - Yellow)” on page 4.

Table 3. Twisted Pair Communication Wiring (S-Bus - Yellow)

Terminals	Purpose
R	24VAC
T T	External indoor temperature sensor (10K Ω or 11K Ω)
OC OC	Occupancy sensor
CM- CM+	S-Bus communication
C	24VAC common

IMPORTANT!

Damage to the CS8500 may occur if 24VAC polarity is not maintained.

Wiring CS8500 (with or without CO₂ Sensor)

Below are the terminal designations and a general description of their purpose.

1. Connect wiring between CS8500 and applicable controller.
2. Connect external sensors if applicable.
3. Seal the hole in the wall with a suitable material to prevent drafts from entering the CS8500 case.
4. Configure CS8500 and equipment for system type and test system.

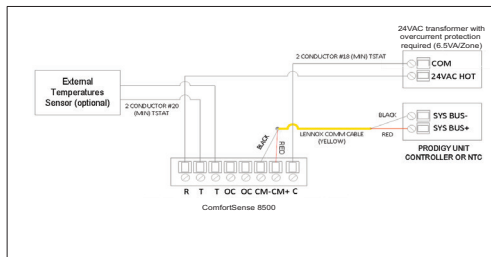

Figure 5. CS8500 Connections (both versions)

Installing Indoor Temperature Sensors

Wire external sensors as illustrated below. Up to nine sensors may be used in averaging sensor applications. Use Lennox catalog numbers 10k Ω (47W37) or 11k Ω (94L61). Sensors are not polarity sensitive.

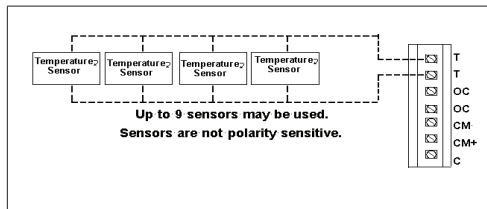

Figure 6. Temperature Sensor Wiring (parallel)

The CS8500 will calculate the average temperature readings from all connected external temperature sensors. If any of the sensors malfunction, they may still report a temperature value. Only when the average value of the connected temperature sensors including any malfunction sensor(s) is lower than -40°F, or higher than 158°F, will the CS8500 determine that an external temperature sensor(s) has failed and switch automatically to the CS8500's internal temperature sensor. A error message will be displayed on the home screen and under the notification screen indicating an "external temperature sensor" error.

Installing Occupancy Sensor

An occupancy sensor can be used with a CS8500 to change the occupancy state from *unoccupied* to *occupied*. The CS8500 will remain *occupied* for as long as the occupancy sensor detects occupancy within the space.

When an occupancy sensor is used, a schedule must be set within the CS8500.

Wiring Steps:

1. Wire the occupancy sensor (normally open) contact (terminal 4) to the CS8500 left (OC) terminal.
2. Wire a jumper wire between CS8500 C terminal and CS8500 right (OC) terminal.
3. Wire the occupancy sensor GND (terminal 2) to the CS8500 C terminal.
4. Wire the occupancy sensor +12-24VAC (terminal 1) to the CS8500 R terminal.

Sequence of Operations

The occupancy sensor input for the CS8500 is intended to be used along with a schedule that will change the occupancy state of the sensor from unoccupied to occupied.

The CS8500 status changes to *occupied* after the CS8500 (while in an unoccupied state) receives a 24VAC input from an enabled occupancy sensor. The CS8500 will begin to use the *occupied* setpoints programmed within the rooftop units Prodigy/ Core backup. These setpoints can only be set at the RTU and not through the CS8500.

The CS8500 will function by the normal scheduled setpoints after the occupancy input from the occupancy sensor is disabled.

NOTE: *The occupancy input from the occupancy sensor has no effect on an occupied CS8500. The occupancy input will only change the state/setpoint of a CS8500 while it is in an unoccupied state.*

Cycle power 1 time on the CS8500 if the CS8500 does not appear to be following setpoints set at the RTU.

The following is an example on how to make connections for a occupancy sensor.

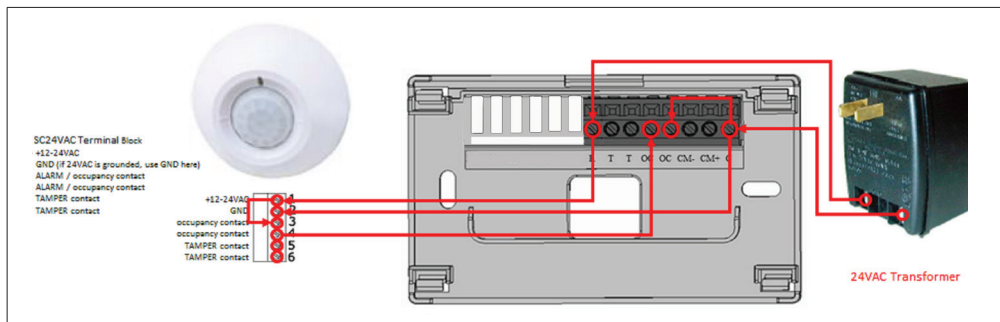

Figure 7. Occupancy Sensor Connections and 24VAC Transformer

Unit Controller S-Bus Setup

A single CS8500 can be connected directly to the S-bus connection on the referenced unit controllers.

M1 / M2 Unit Controller Setup

From the main menu, perform the following navigation through the menus to set the S-Bus address for L Connection.

M1 / M2 Unit Controller - Control Mode and Backup Set Points Setup

The following options must be set when the CS8500 is used.

ECTO 5.27 - This is use and depends on the available sensors on the CS8500. Room temperature reading is standard on all models. The following setting instructs the M1/M2 unit controller what source to get zone temperature, CO₂, and indoor RH input.

- 2 = Room temperature (A2)
- 3 = Room temperature and IAQ (A63)
- 10 = Room temperature and indoor RH (A91)
- 11 = Room temperature, IAQ, and indoor RH

ECTO 6.01 - Is used to configure the M1/M2 unit controller control mode and back-up set points to use. Options are:

- 1 = Zone sensor mode with no backup.
- 2 = Zone sensor mode with local sensor backup.
- 3 = Zone sensor mode with return air sensor backup.

M3 Unit Controller Setup

From the main menu, perform the following navigation through the menus to set the S-Bus address for L Connection.

1. Go to **SETUP > NETWORK INTEGRATION > L-CONNECTION > LCONN ADDRESS**.
2. Enter the desired LCONN ADDRESS (S-BUS) and select **SAVE** to continue.
3. Set **CONTROL MODE** = Room Sensor and select **SAVE** to continue.
4. **NETWORK SENSOR C02** should be set to either **YES** or **NO**. Select **SAVE** to continue.
5. **RELATIVE HUMIDITY** should be set to either **YES** or **NO**. Select **SAVE** to continue.
6. **TEMPERATURE** should be set to either **YES** or **NO**. Select **SAVE** to continue.
7. Continue to answer the various configuration questions until the wizard returns you to the **NETWORK INTEGRATION** menu option.

NOTE: *Once the configuration is saved, then S-Bus communication will be lost and alarm 110 (low priority) will be raised. This will be cleared automatically when any demand goes to M3.*

M4 Unit Controller Setup

From the main menu, perform the following navigation set the S-Bus configuration.

1. Go to **Menu** and select **Network Integration > Network Setup Wizard**. Then select **S-Bus/Wireless Sensor** and then select **NEXT**.
2. Enter the desired **S-Bus Address** and select **NEXT**.
3. Select **Control Source** = **Room Sensor**. Then select **NEXT** to continue.
4. **NETWORK SENSOR C02** should be set to either **YES** or **NO**. Select **SAVE** to continue.
5. **RELATIVE HUMIDITY** should be set to either **YES** or **NO**. Select **SAVE** to continue.
6. **TEMPERATURE** should be set to either **YES** or **NO**. Select **SAVE** to continue.
7. Continue to answer the various configuration questions until the wizard returns you to the **NETWORK INTEGRATION** menu option.

NOTE: *Once the configuration is saved, then S-Bus communication will be lost and alarm 110 (low priority) will be raised. This*

will be cleared automatically when any demand goes to M4

CS8500 Setup

1. From the CS8500's home screen, go to **MENU** > **TECHNICIAN SETTINGS** and enter **864** and press **OK** to proceed.
2. Both the RTU and the CS8500 must be set to the same S-Bus address. The rooftop units default address is 2 unless it has been changed. If it has not change then set the CS8500 S-Bus address to 2.
3. Set operation with Smart Hub to ON/OFF.
 - If the CS8500 is setup with the rooftop units with NCP, set this to ON.
 - If the CS8500 is setup standalone with the rooftop unit and no NCP, set this to OFF.
 - If the CS8500 is being used in a BACNet configuration, set this to ON and read section (BACNet section) for further instruction.

NOTE: *It may take 30 seconds up to two minutes for the CS8500 to connect.*

BACnet with M3/M4 Unit Controller

This section describes how a CS8500 operates in a BACnet environment with a M3 and M4 unit controller.

Network Topology

- All rooftop units are connected to the BACnet front-end.
- Each rooftop unit is connected to one CS8500.

- The CS8500 communicates with the rooftop units using the Lennox proprietary S-Bus protocol.

CS8500 Set Point Change

The BACnet front-end provides the occupied and unoccupied set points to the roof top unit.

The roof top unit (RTU) sends the same set points to CS8500. The rooftop units uses these set points until the CS8500 provides a new set point. When the user changes the set point at the CS8500, it communicates the same to M3/M4 unit controller. Upon receiving this information, the M3/M4 unit controller starts an override timer and uses the new set points until the timer expires.

- While the timer is active, if BACnet queries the M3/M4 unit controller, it will be informed that the rooftop units is using the override set points.
- When the timer expires, both the M3/M4 unit controller and CS8500 reverts to the set points provided by BACnet.

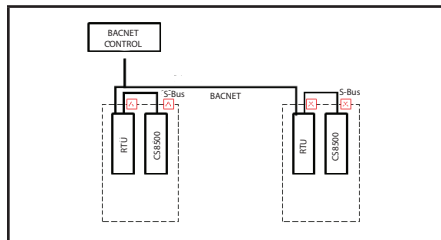

Figure 8. BACnet and CS8500

CS8500 Occupancy Override

- Rooftop units use occupied or unoccupied set points based on the occupancy status supplied by the BACnet front-end.
- The user has the option to override the system into occupied status using the CS8500.
- When the user overrides occupancy at the CS8500, it communicates the same occupied status to the M3/M4 unit controller.
- Upon receiving this information, the M3/M4 unit controller starts an override timer and uses the occupied set points until the timer expires.
- The CS8500 also remains in occupied mode as long as the override timer is active.
- While the timer is active, if BACnet queries the M3/M4 unit controller, it will be informed that the rooftop unit is occupied and is using the occupied set points.
- When the timer expires, both the M3/M4 unit controller and CS8500 reverts to the occupancy status provided by the BACnet front end.

BACnet Canceling Override

When the user changes the set point or occupancy mode at the CS8500, it puts the M3/M4 unit controller into override mode. The BACnet front-end has the option to cancel the override timer at any time by sending a value of **3** to the M3/M4 BACnet Analog Object 103. When the timer is canceled, the rooftop units and CS8500 returns to using the occupancy

status or set points provided by the BACnet front-end.

Sensor Inputs

The M3/M4 unit controller can be configured to use temperature, relative humidity and/or CO₂ provided by the CS8500.

NOTE: *The occupancy sensor input wired into the CS8500 cannot be utilized in this mode.*

M3 Unit Controller Setup

BACnet compatibility with the M3 unit controller requires firmware version 08.03.0120 or higher. To configure the M3 unit controller to work with the CS8500 use the following procedure:

1. Go to **MAIN MENU > SETTINGS > RTU OPTIONS > EDIT PARAMETERS**. Edit parameter 385 and set to 1.

NOTE: *Modifying 385 to 1 allows both the CS8500 and M3 unit controller to co-exist.*

2. Go to Prodigy **MAIN MENU > SETTINGS > GENERAL** and set **CONFIGURATION ID1**, position **5** to **B**.
3. Go to **SETUP** and select **NETWORK INTEGRATION**.
4. Use the adjust and set values arrows to display **L-CONNECTION** and press the **SAVE** button to continue.
5. Adjust the **L-CONNECTION ADDRESS** if required and press **SAVE** button to continue.

NOTE: Both the L-Connection address and CS8500 address setting will need to be exactly the same.

6. **CONTROL MODE** will need to be set to **ROOM SENSOR**. Press the **SAVE** button to continue.
7. **NETWORK SENSOR > CO₂** needs to be set to **YES** (optional). Press the **SAVE** button to continue.
8. **NETWORK SENSOR > RELATIVE HUMIDITY** needs be set to **YES** (optional). Press the **SAVE** button to continue.
9. **NETWORK SENSOR > TEMPERATURE** will need to be set to **YES** (optional).
10. Continue to answer the various configuration questions until the wizard returns you to the **NETWORK INTEGRATION** menu option.

NOTE: Once the configuration is saved, then BACnet communication will be lost and alarm 110 (low priority) will be raised. This will be cleared automatically when any demand goes to M3.

11. Go to **SETUP** and select **NETWORK INTEGRATION**.
12. Use the adjust and set values arrows to display **BACNET** and press the **SAVE** button to continue.
13. Adjust the **BACNET ADDRESS** if required and press **SAVE** button to continue.

NOTE: BACnet address and baud rate is to be determined and/or set by the systems integrator.

14. Adjust the **BACNET BAUD RATE** and press **SAVE** button to continue.

15. **CONTROL MODE** will need to be set to **ROOM SENSOR**. Press the **SAVE** button to continue.
16. **NETWORK SENSOR > CO₂** (if equipped) needs to be set to **NO** (if choosing CO₂ from CS8500). Press the **SAVE** button to continue.
17. **NETWORK SENSOR > RELATIVE HUMIDITY** needs be set to **NO** (if choosing RH from CS8500).
18. **NETWORK SENSOR > TEMPERATURE** will need to be set to **NO** (if choosing temperature from CS8500).
19. Continue to answer the various configuration questions until the wizard returns you to the **NETWORK INTEGRATION** menu option.

NOTE: Once the configuration is saved, then BACnet communication will be lost and alarm 110 (low priority) will be raised. This will be cleared automatically when any demand goes to M3.

M4 Unit Controller Setup

To configure the M4 unit controller to work with the CS8500 use the following procedure:

1. Go to **Menu** and select **Network Integration** and select **Network Setup Wizard**.
2. Select **BACnet MS/TP**. Then select **NEXT** to continue.
3. Assign the **MAC Address, Device Instance** and **Baud rate**. Then select **NEXT** to continue.

NOTE: The CS8500 MAC address setting will need to be exactly the same.

4. Select **Control Mode** and then select **Room Sensor**. Then select **NEXT** to continue.

5. For **CO2 Sensor Source**, select SBUS if using a CS8500 equipped with CO2. Otherwise, select **Local/None** (for M4 wired sensor or no sensor) or **Network** (if value will be provided via BACnet). Select **NEXT** to continue.
6. For **Relative Humidity Sensor Source**, select **SBUS** if the humidity value from the CS8500 should to control the system. Otherwise, select **Local/None** (for M4 wired sensor or no sensor) or **Network** (if value will be provided via BACnet). Select **NEXT** to continue.
7. For **Temperature Sensor Source**, select **SBUS** if the temperature value from the CS8500 (or CS8500 remote sensor) should control the system. Otherwise, select **Local/None** (for M4 wired sensor or no sensor) or **Network** (if value will be provided via BACnet) Select **NEXT** to continue.
8. Continue to answer the various configuration questions until the wizard returns you to the **NETWORK INTEGRATION** menu option.

NOTE: *Once the configuration is saved, then BACnet communication will be lost and alarm 110 (low priority) will be raised. This will be cleared automatically when any demand goes to M4.*

CS8500 Setup

1. From the CS8500's home screen, go to **MENU > TECHNICIAN SETTINGS** settings and enter 864 and press **OK** to proceed.
2. Both the RTU and the CS8500 must be set to the same S-Bus address. The RTU default address is 2 unless it has been changed. If it has not change then set the CS8500 S-Bus

address to 2.

3. Set operation with Smart Hub (Central Hub) to ON.

CS8500 Sensor Failure

If the CS8500 sensor fails and return air backup is set up as the back operation (highly recommended), the RTU will revert to its return air temperature for space temperature and set points from BACnet.

Functions Not Supported with BACnet Operation

- Zoning
- Occupancy sensor input from the CS8500
- BACnet monitor mode
- In this operation, BACnet cannot refresh/reload set point override timers; occupancy override timers must be refreshed from the space.

CS8500 Troubleshooting

1. Make sure 24VAC is supplied to the CS8500.
2. Make sure the CS8500 S-Bus address setting matches the M2/M3/M4 unit controller address.
3. Check communication cable wiring.
4. Verify that the sensor data from the CS8500 display matches the Prodigy Unit Controller (or Lennox® CORE Unit Controller) display or mobile application.
5. For the M1 unit controller (IMC), use the IMC MODE TEMP switch to display the data.
6. For the M2 unit controller:

Go to: **DATA > SENSORS** menu to display the data.

7. For the M3 unit controller:

Go to: **DATA > IN/OUTPUT > SENSORS > NETWORK**

8. For the M4 unit controller:

Go to: **DATA > SYSTEM DATA/SENSORS/OUTPUTS > INPUTS AND OUTPUTS > NETWORK INPUTS**

M3/M4 Unit Controller - Setting Return Air Temperature Limits

The M3/M4 unit controller may be set up to monitor return air temperature and interrupt the demand if return temperature is above the heating adjustable limits. To enable this feature set parameters 113 and 115 locally at the M3/M4 unit controller which is located inside the Lennox rooftop unit.

- Adjusting parameter 113 enables return room temperature limits. Default is **0** (OFF). To enable set to **1** (ON).

Go to: **SETTINGS > RTU OPTION > EDIT PARAMETER = 113 (EN RET AIR TMP LMT)**.

- Adjusting parameter 115 is used to interrupt a heating demand. Default is 85.0°F. Adjustable range is 60.0°F to 100.0°F.

Go to: **SETTINGS > RTU OPTION > EDIT PARAMETER = 115 (HEAT RET AIR LIMIT)**

If return air temperature is above the adjustable limits, alarm code 40 will be displayed but not stored in memory for recall.

Menu

Select the three lines in the upper right-hand corner of the home screen to access the menu. Selectable options under menu are notifications and settings.

NOTE: Refer to the included user guide for more details on the following menu selections.

- **Notifications** - When a system error or reminder occurs, a pop-up screen will appear indicating the condition. (See user guide for details.)
- **Performance Reports** (only available when “Operation with Smart Hub” is set to OFF.) (See user guide for details.)

NOTE: Smart Hub reference is concerning Central Hub.

- **Edit Schedule** (only available when “Local Scheduling Function” is set to ON.) (See user guide for details.)
- **Owner Settings** (See user guide for details.)
- **Technician Settings** (See the following section for details).

Technician Settings

During initial power up of the CS8500, the technician settings menu will appear first. The S-Bus address option must be selected and a address set before you can proceed. Use either the minus/plus buttons or numeric keypad to enter the address. After the S-Bus address is set, press the back button to return to the technician settings menu.

NOTE: If you need to access the technician settings option in the future, go to the home page, press menu > technical settings and enter technician PIN code 864. This code cannot be changed.

Parameter Settings Based on System Configuration

The first parameters (S-Bus Address) will always need to be set.

Available bus addresses are 1 through 31.

Other settings are available based on whether operations with smart hub and local scheduling functions is set to ON or OFF.

The second and third parameter is operation with smart hub and local scheduling.

That option is either ON or OFF for both. Default is OFF for both. Available parameters settings are dependent on whether either parameter is ON or OFF. See the following table to determine available parameters based on OFF or ON.

Table 4. Parameter Settings based on System Configuration

Parameters	Setting Available when Operation with Smart Hub is ON or OFF	Setting Available when Local Scheduling is set to ON or OFF
Display on home screen	ON or OFF	ON or OFF
Contractor info	ON or OFF	ON or OFF
Temperature sensor config.	ON or OFF	ON or OFF
Smooth setback recovery (SSR)	OFF	ON
Offsets	ON or OFF	ON or OFF
Temperature adjustment range	ON or OFF	ON or OFF
Remember override set point	OFF	ON
Schedule hold setting	OFF	ON
Reminders	OFF	ON or OFF
Reset to factory defaults	ON or OFF	ON or OFF
Change owner pin	ON or OFF	ON or OFF
RTU fan on/auto user control	ON or OFF	ON or OFF

Parameter Descriptions

1. S-Bus Address

Options are 1 through 31. Select address and press the set button to save the setting and return to the technician setting screen.

NOTE: *S-Bus address should be the same as the address being used by either the NTC or unit controller which you wish to control with the CS8500.*

2. Operation with Smart Hub

When set to off the CS8500 can communicate directly with a Prodigy Unit Controller (or Lennox® CORE Unit Controller) via the S-Bus. Default is off.

In addition, when set to ON, this function will allow the CS8500 to operate in a BACnet network with an M3/M4 Unit Controller.

3. **Local Scheduling Function**

This feature provides the ability to setup a local schedule. When set to ON, several options are available. Once schedules have been defined, the scheduling function can be turned on from the home screen by selecting heat/cool on the home screen and select mode schedule.

If the CS8500 is in stand-alone mode, local scheduling can be used. Adjusting the temperature set points on the CS8500 will put the unit in an override period.

4. **Display on Home Screen**

Turn ON or OFF for the followings options. Factory default is set to OFF.

- RTU Fan
- CO₂ value (only on models with CO₂ sensor)
- RTU function state
- Service required alert

Factory default is OFF for all of the above options. Press < in the upper left-hand corner of the screen to return to the technician settings menu.

5. **Contractor Info**

Information to be completed for this option is name, address, phone, email and website. Press < in the upper left-hand corner of the

screen to return to the technician settings menu.

6. **Temperature Sensor Config**

Temp. Sensor source by default is set to internal temp. sensor. The other option is external temp. sensor(s). When external temp. sensor(s) is selected, the following settings need to be configured;

- Number of external temp. sensor. Default is 1 and up to 9 can be selected.
- Type of external sensor. Options are 10k sensor type 2 (47W37) or 11k sensor type 2 (94L61). Default sensor type is 10k sensor type 2.

Press < in the upper left-hand corner of the screen to return to the technician settings menu.

7. **Smooth Setback Recovery (SSR)**

Options are enable or disable. Default is Enabled.

When enabled, smooth set recovery begins recovery up to two hours before the programmed time so that the programmed temperature is reached 6°F per hour at the corresponding programmed event time and is applicable for all equipment settings. With smooth set recovery disabled, the control will start a recovery at the programmed time.

8. Offsets

- Internal temp. Sensor offset: Offset for the built-in temperature sensor (internal) is -5°F to +5°F. Default is 0°F.
- External temp. sensor offset (only selectable when external temp. sensor is selected under temperature sensor config.): Offset for the external temp, sensor is -5°F to +5°F. Default is 0°F.
- Humidify offset: The setting option for this is -10% to +10%. Default is 0%.
- CO₂ sensor offset: Offset for the CO₂ sensor is -200ppm to + 200 ppm. Default is 0 ppm. (Only on models with internal CO₂ sensor.)

9. Temperature Adjustment Range

The adjustment range for screen unlock is 0 to 10 degrees in increments of one degree. The default setting is 2. There is a ON / OFF adjustment for screen lock as well.

When the Local Scheduling function is set to OFF and operations with the Smart Hub is set to OFF, the CS8500 will use the heating and cooling, unoccupied and occupied set points from the Prodigy controller (or Lennox® CORE Unit Controller). These can only be adjusted at the rooftop unit.

10. Remember Override Set Point

This setting is only available when local scheduling is set to ON. When an override is set the status text will display “Period of Time”

instead of “Schedule Hold”

When an override is set the unit will remember this override setting for the current occupied period and re-apply it at the same occupied period, every time it occurs.

This setting will be able to be enabled or disabled.

11. Schedule Hold Settings

This is a setting for hold until next scheduled period option. Options are enable or disable. Default is enabled.

When a user sets an override the unit will allow the user to set the duration of the override to “1 hour, 2 hours, or Until the Next Scheduled Period.”

The Technician Settings can allow a user to disable the “*Until Next Scheduled Period*” option when unoccupied. This option applies to stand-alone mode.

12. Reminders

Two customer reminders can be set and a routine system check up.

- For both reminders, the name change be customized and date and time set.
- For routine system check up the date and time can be set.

13. Reset to Factory Defaults

There are five options under this setting, partial reset and all reset.

- **Reset reminders.**
- **Reset schedule.**
- **Reset all settings** - Resets everything to default.
- **Reset all owner settings** - Resets all owners settings listed under general display menus.
- **Reset technician settings:** Resets all technician settings listed on the technician menu.

Press < in the upper left-hand corner of the screen to return to the technician settings menu.

14. **Change Owner Pin**

This option is used to create or change the owner pin number when screen lock is enabled under the **owner settings > generals settings**. The default owner pin is 864. Screen lock can be set from home screen > **menu > owner settings > general**. Screen lock ON or OFF. Default is OFF.

15. **RTU Fan On/Auto User Control**

Options are OFF and ON. Default is OFF. When this is set to on:

- RTU FAN is displayed on the home screen.
- FAN setting option is displayed under owner settings menu.

When this is set to OFF, fan is not displayed and fan option under owner settings is not available.

System Status Descriptions

The system status screen icons can be access by pressing the *** (three dots) which is located on the left side of the home screen. Then press the view status option.

Press the red toolbox to access the technician system status screen. Technician pin 864 is required to access that screen.

NOTE: *The technician pin cannot be changed.*

Table 5. System Status Descriptions



State (Icon)	Icon Location	Description
 heating	Home Screen	When current RTU function is heating, this icon will be displayed.
 cooling	Home Screen	When current RTU function is cooling, this icon will be displayed.
 HP defrosting	Home Screen	When current RTU function is defrosting, this icon will be displayed.
 dehumidifying	Home Screen	When current RTU function is dehumidifying, this icon will be displayed.
 fan is auto	Home Screen	When fan operation was set to auto, if blower of RTU is ON, this icon will be displayed.
 fan is on	Home Screen	When fan operation was set to on, if RTU blower is ON, this icon would be displayed.

Table 5. System Status Descriptions

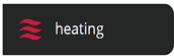
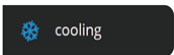

State (Icon)	Icon Location	Description
	Home Screen	This icon is displayed on the screen in CO ₂ mode. If display function is turned on.
	Home Screen	When either of following error occur, this icon would be displayed. <ul style="list-style-type: none"> • Some RTU compr. Locked • All RTU compr. Locked • RTU fault state - fault detected • CS fault state - fault detected
	Home Screen	Display during smooth setback recovery (SSR) execution.
	Technician Status Screen	There are communication errors.
	Technician Status Screen	Lost communications with host.
	Technician Status Screen	There are no communication errors.
	Technician Status Screen	When RTU state is warm-up mode coming out of an unoccupied state, this icon will be displayed.
	Technician Status Screen	When RTU state is cool-down mode coming out of an unoccupied state, this icon will be displayed.

Table 5. System Status Descriptions

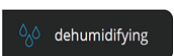
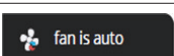
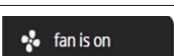



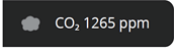

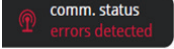
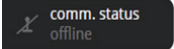
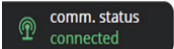
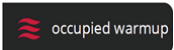
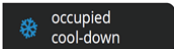
State (Icon)	Icon Location	Description
 F.A.T heating	Technician Status Screen	Fresh air tempering heating.
 F.A.T cooling	Technician Status Screen	Fresh air tempering cooling.
 F.A.T dehumidifying	Technician Status Screen	Fresh air tempering dehumidifying.
 some RTU compr. locked	Technician Status Screen	This status is displayed when the RTU compressor has partially failed (or generates an error).
 all RTU compr. locked	Technician Status Screen	This status is displayed when all RTU compressors have failed (or error occurred).
 RTU fault state fault detected	Technician Status Screen	RTU faults detected.
 RTU fault state zero faults	Technician Status Screen	No RTU faults detected.

Table 5. System Status Descriptions

State (Icon)	Icon Location	Description
	Technician Status Screen	<p>When the CS8500 (CS) has a fault state, this icon would be displayed.</p> <p>The following possible errors may have occurred which would generate this system status:</p> <ul style="list-style-type: none">• Local temperature sensor error• External sensor error• Memory error• Humidity sensor error• CO₂ sensor error
	Technician Status Screen	No faults detected

Error Codes and Reminders

Any active history for notifications are listed under **menu > notification**. Press the down arrow icon next to the notification to expand the notification for further details. Press the contractor info option for assistance.

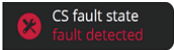
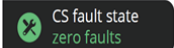
Table 6. Error Codes and Reminders

Condition	Issue	Display	System Action	Action to Clear / Recovery Condition
Critical	Built-In Temp Sensor error - temperature sensor reads -4°F or less or 158°F (+/- 5°F) or greater.	Temperature Sensor Error	<ul style="list-style-type: none"> Indoor temp is displayed as "--" on the home screen. This error is displayed on the notification screen as well. 	<ul style="list-style-type: none"> If the sensor starts detecting a normal operating range, the error message will automatically clear and the system will return to normal operation. Contact service contractor to replace the CS8500.
Critical	Remote temperature sensor error. External sensor reads -4°F or less or 158°F (+/- 5°F) or greater.	External Sensor Error	<ul style="list-style-type: none"> Indoor temp is displayed as "--" on the home screen. This error is displayed on the notification screen as well. When configured for external temperature sensors and there is an error, the unit will automatically switch to the internal temperature sensor. 	<ul style="list-style-type: none"> If the sensor starts detecting a normal operating range, the error message will automatically clear and the system will return to normal operation. Contact service contractor to replace the external temperature sensor. Other than replacing the CS8500, go to the technician setting > temperature sensor config. and change the temperature sensor source back to internal temperature sensor. That will remove the error message from the home and notification screens.

Table 6. Error Codes and Reminders

Condition	Issue	Display	System Action	Action to Clear / Recovery Condition
Critical	EEPROM error (power-on)	Memory Error	<ul style="list-style-type: none"> • System will restore all settings to factory default and resume operations. • This error is displayed on the notification screen as well. 	Contact service contractor to replace the CS8500.
Critical	EEPROM error (operating)	Memory Error	<ul style="list-style-type: none"> • System will operate in normal mode until power off. • This error is displayed on the notification screen as well. 	Contact service contractor to replace the CS8500.
Critical	Humidity sensor error (without Humidifier or Dehumidifier): Sensor reads out of range 0% to 100%	Humidity Sensor Error	<ul style="list-style-type: none"> • The reading for humidity is not valid. This message indicates humidity sensor is not working correctly. When there is an error the home screen humidity display will indicate "--". • This error is displayed on the notification screen as well. 	<ul style="list-style-type: none"> • Contact service contractor to replace the CS8500. • If the sensor starts detecting a normal operating range, the error message will automatically clear and the system will return to normal operation.

Table 6. Error Codes and Reminders

Condition	Issue	Display	System Action	Action to Clear / Recovery Condition
Critical	CO ₂ Sensor error - sensor reads out of range (above 3500 ppm)	CO ₂ Sensor Error	<ul style="list-style-type: none"> • The reading for CO₂ is not valid. This message indicates CO₂ sensor is not working correctly. • The display of Indoor CO₂ from HOME will be "--". • This error is displayed on the notification screen as well. 	<ul style="list-style-type: none"> • Contact service contractor to replace the CS8500. • If the sensor starts detecting a normal operating range, the error message will automatically clear and the system will return to normal operation
Critical	Comm error state at start-up.	Comm Status – Errors Detected	<ul style="list-style-type: none"> • When the failed (off-line) state is detected, continue listening for a valid message. • If this occurs then normal operation should resume. • This error is displayed on the notification screen as well. 	<ul style="list-style-type: none"> • Contact service contractor to check communication wire connection. • If a valid message is received, then the error message will be automatically cleared and system will resume normal operations.
Critical	Some RTU compressors Locked	Some RTU Compressors Locked	This error is displayed in notification screen and technician system status screens.	<ul style="list-style-type: none"> • User will have to contact the Service Contractor to have the system serviced. • Will need to check RTU state • If the RTU recovered from the error automatically the error will also automatically clear.

Table 6. Error Codes and Reminders

Condition	Issue	Display	System Action	Action to Clear / Recovery Condition
Critical	All RTU compressors Locked	All RTU compressors Locked	This error is displayed in notification screen and technician system status screens.	<ul style="list-style-type: none"> • User will have to contact the Service Contractor to have the system serviced. • Will need to check RTU state • If the RTU recovered from the error automatically the error will also automatically clear.
Critical	RTU Fault State Detected	RTU Fault State Detected	This error is displayed in notification screen and technician system status screens.	<ul style="list-style-type: none"> • User will have to contact the Service Contractor to have the system serviced. • Will need to check RTU state. • If the RTU recovered from the error automatically the error will also automatically clear.
Reminder	Routine system check up	Routine system check up	Displayed on notification screen.	<ul style="list-style-type: none"> • Pressing clear button will clear the reminder. • Or pressing remind later on pop-up screen will extend the duration.
Reminder	Custom reminder 1	User Editable	Displayed on notification screen.	<ul style="list-style-type: none"> • Pressing clear button will clear the reminder. • Or pressing remind later on pop-up screen will extend the duration.
Reminder	Custom reminder 2			

Table 6. Error Codes and Reminders

Condition	Issue	Display	System Action	Action to Clear / Recovery Condition
Minor	Outdoor Temperature (RT17) Sensor Problem	Outdoor Temp Sensor	Displayed on notification screen.	If measurement of the outdoor temperature sensor is out of specified range (including open / short detection), the alarm will be activated. Alarm will automatically clear once in range condition is detected. Check sensor and wiring.
Minor	Discharge (Supply) Air Temperature Sensor (RT6) problem.	Discharge Air Temp Sensor	Displayed on notification screen.	If measurement of the discharge air temperature sensor is out of specified range (including open / short detection), the alarm will be activated. Alarm will automatically clear once in range condition is detected.
Minor	Return Air Temperature Sensor (RT16) problem	Return Air Temp Sensor	Displayed on notification screen.	If measurement of the return air temperature sensor is out of specified range (including open / short detection), the alarm will be activated. Alarm will automatically clear once in range condition is detected. Check sensor and wiring.
Minor	Advanced Airflow Low Outdoor Airflow	Economizer Fault	Displayed on notification screen.	Outdoor airflow is too low so the building is not getting the designed outdoor airflow based on IAQ.

Table 6. Error Codes and Reminders

Condition	Issue	Display	System Action	Action to Clear / Recovery Condition
Minor	Advanced Airflow Outdoor Airflow Too High	Economizer Fault	Displayed on notification screen.	Ventilation CFM is too high so the RTU is wasting energy.
Minor	Outdoor Air Damper Error (During Free Cooling)	Economizer Fault	Displayed on notification screen.	During free cooling damper is not modulating.
Minor	Not Economizing When Outdoor Air is Suitable	Economizer Fault	Displayed on notification screen.	May be due to the damper motor being unplugged or disconnected.
Minor	Economizing When Outdoor Air is Not Suitable	Economizer Fault	Displayed on notification screen.	This may be due to damper motor being blocked or stuck open and therefore not closing.

